

*Switching Power Supplies  
From 5W to 960W*

*Enclosed Type  
Low Profile  
DIN Rail Type*



# Control

## Switching Power Supplies

CARLO GAVAZZI offers a versatile line of SPD Series industrial DIN-rail mounted, SPM Series low profile, and SPP Series enclosed switching power supplies. Many features considered optional with some competitors are included as standard features throughout our product line. Selection of the power supply is accomplished by matching the output voltage and output power to the application. Power Factor Correction (PFC), parallel operation or the need for an output status relay, come as standard features on many SPD power supplies.



Three-phase models are rated 400 - 500VAC, and may also be powered using 380 - 575VAC single phase input voltage. The SPP enclosed series is a chassis mounted, compact and robust DC power solution available in 20, 35 and 60 watt configurations. All CARLO GAVAZZI single and three-phase switching power supplies offer high efficiencies, exceptional specifications, high quality and carry global certifications. Each provides a wide range of universal input voltages, screw terminal connection options, long term reliability and money saving space optimization for the panel builder.



**Diagnostic Warning**



**Inventory Reduction**



**Space Optimization**



**User Friendly**



**Long Term Reliability**

### High Efficiency

The power supply's typical efficiency is very high, up to 93%.

### Universal Input

On all models, the rated input voltage is automatically selected by the power supply. On the three phase models, the input voltage can be provided by three phase or just two phase connections.

### Adjustable Output

The vast majority of the DIN rail models provide a front potentiometer, to adjust the output voltage, generally within a span of  $\pm 10\%$  of the rated voltage.

### "Bi-phase" Input

A 100W power supply is available with a high-voltage single phase input. The SPDxx1002 can be powered by 380 - 575VAC.

### Power Factor Correction

PFC function is standard on all SPD wattage outputs from 90 - 960W.

### Parallel Connection

Most of the power supplies can be connected in parallel with one identical unit in order to double the power. Some models allow connection of up to three units.

### Visual and Electrical Indications

Most of the models are equipped with double LED indication: one for output voltage and one for power ready. The 24VDC output types also offer a contact output for power ready.

### Approvals and Warranty

All power supplies are approved according to relevant European and North American safety standards. All models feature a two year warranty.



SPD Single Phase		Item Number	W	Vin VAC	Vin VDC	Vout VDC	Iout A
Screw Terminal	Spring Terminal						
SPD05051	SPD05051B	5W	90 - 265	120 - 370	5	1	
SPD12051	SPD12051B				5	1	
SPD15051	SPD15051B				12	0.42	
SPD24051	SPD24051B				24	0.21	
SPD05101	SPD05101B	10W	90 - 265	120 - 370	5	2	
SPD12101	SPD12101B				12	0.84	
SPD15101	SPD15101B				15	0.67	
SPD24101	SPD24101B	18W	90 - 265	120 - 370	24	0.42	
SPD05181	SPD05181B				5	3	
SPD12181	SPD12181B				12	1.5	
SPD15181	SPD15181B				15	1.2	
SPD24181	SPD24181B	30W	85 - 264	90 - 375	24	0.75	
SPD05301	SPD05301B				5	6	
SPD12301	SPD12301B				12	2.5	
SPD24301	SPD24301B				24	1.25	
SPD48301	SPD48301B	60W	85 - 264	90 - 375	48	0.625	
SPD05601	SPD05601B				5	10	
SPD12601	SPD12601B				12	5	
SPD24601	SPD24601B				24	2.5	
SPD48601	SPD48601B	90W	90 - 264	120 - 375	48	1.25	
SPD24901L	ST, PE, RDY out				24	3.8	

Item Number	SPD Single Phase Description	W	Vin VAC	Vin VDC	Vout VDC	Iout A
SPD121001	ST, PF, PE	100W	90 - 264	120 - 375	12	8.4
SPD241001	ST, PF, RDY out, PE				24	4.2
SPD481001	ST, PF, PE				48	2.1
SPD24901	ST, PFC, PF, ME	90W	90 - 264	120 - 375	24	3.8
SPD24901B	RC, PFC, PF, ME				24	3.8
SPD121201	ST, ME	120W	93 - 264	210 - 370	12	10
SPD121201B	RC, ME				12	10
SPD241201	ST, RDY out, ME				24	5
SPD241201B	RC, RDY out, ME				24	5
SPD481201	ST, ME	240W	90 - 264	210 - 370	48	2.5
SPD481201B	RC, ME				48	2.5
SPD121201N	ST, PFC, PF, ME				12	10
SPD121201BN	RC, PFC, PF, ME				12	10
SPD241201N	ST, PFC, PF, RDY out, ME	300W	90 - 264	210 - 370	24	10
SPD241201BN	RC, PFC, PF, RDY out, ME				24	10
SPD481201N	ST, PFC, PF, ME				48	10
SPD481201BN	RC, PFC, PF, ME				48	10
SPD122401C	ST, PFC, PF, RDY out, ME	480W	93 - 264	210 - 370	12	16
SPD122401CB	RC, PFC, PF, RDY out, ME				12	16
SPD242401	ST, PFC, PF, RDY out, ME				24	10
SPD242401B	RC, PFC, PF, RDY out, ME				24	10
SPD242401C	ST, PFC, PF, RDY out, ME	300W	90 - 264	210 - 370	24	10
SPD242401CB	RC, PFC, PF, RDY out, ME				24	10
SPD482401	ST, PFC, PF, ME				48	5
SPD482401B	RC, PFC, PF, ME				48	5
SPD243001	ST, PFC, PF, RDY out, ME	480W	90 - 264	210 - 370	24	12.5
SPD243001B	RC, PFC, PF, RDY out, ME				24	12.5
SPD483001	ST, PFC, PF, ME				48	6.25
SPD483001B	RC, PFC, PF, ME				48	6.25
SPD244801	ST, PFC, PF, RDY out, ME	480W	210 - 370	210 - 370	24	20
SPD244801B	RC, PFC, PF, ME				24	20
SPD484801	ST, PFC, PF, ME				48	10
SPD484801B	RC, PFC, PF, ME				48	10

Item Number	SPD Bi and Three Phase Description	W	Vin VAC	Vin VDC	Vout VDC	Iout A
SPD121002	2ph, ST, PF, PE	100W	340 - 575	480 - 820	12	8.4
SPD241002	2ph, ST, PF, RDY out, PE				24	4.2
SPD481002	2ph, ST, PF, PE				48	2.1
SPD121203	3ph, ST, PFC, ME	120W	340 - 575	480 - 820	12	10
SPD241203	3ph, ST, PFC, RDY out, ME				24	5
SPD242403	3ph, ST, PFC, PF, RDY out, ME	240W	340 - 575	480 - 820	24	10
SPD482403	3ph, ST, PFC, PF, ME				48	5
SPD244803	3ph, ST, PFC, PF, RDY out, ME	480W	340 - 575	480 - 820	24	20
SPD484803	3ph, ST, PFC and PF, ME				48	10
SPD249603	3ph, ST, PFC, APF, RDY out, ME	960W	340 - 575	480 - 820	24	40
SPD249603L	3ph, ST, PFC, ME				24	40
SPD489603	3ph, ST, PFC, APF, ME				48	20

Item Number	SPM Low Profile Single Phase Description	W	Vin VAC	Vin VDC	Vout VDC	Iout A
SPM1051	1DIN module, ST, PE	7.5W	90 - 264	120 - 370	5	1.5
SPM1121	1DIN module, ST, PE	10W			12	0.83
SPM1151	1DIN module, ST, PE				15	0.67
SPM1241	1DIN module, ST, PE				24	0.42
SPM3051	3DIN module, ST, PE	15W			5	3
SPM3121	3DIN module, ST, PE	25W			12	2.1
SPM3151	3DIN module, ST, PE	30W			15	2
SPM3241	3DIN module, ST, PE				24	1.3
SPM4051	4DIN module, ST, PE	35W			5	7
SPM4121	4DIN module, ST, PE	54W			12	4.5
SPM4151	4DIN module, ST, PE	60W	15	4		
SPM4241	4DIN module, ST, PE		24	2.5		
SPM5051	5DIN module, ST, PE	72W	5	12		
SPM5121	5DIN module, ST, PE		12	6		
SPM5151	5DIN module, ST, PE	75W	15	5		
SPM5241	5DIN module, ST, PE	100W	24	4.2		
SPM5241S	5DIN module, ST, PE	91W	24	3.8		

Item Number	Redundant Module Description	Vin VDC	Vout VDC	Iout A
SPD24RM20	SPD Series Redundant Module 24Vin	5-24	24	20
SPM2RM2410	SPM Series Redundant Module 24Vin	5-24	24	10

Item Number	SPP1 Enclosed Single Phase Description	W	Vin VAC	Vin VDC	Vout VDC	Iout A
SPP1 05201	Enclosed Type, ST, PE	20W	88 - 264	120 - 375	5	4
SPP1 12201	Enclosed Type, ST, PE				12	1.7
SPP1 15201	Enclosed Type, ST, PE				15	1.4
SPP1 24201	Enclosed Type, ST, PE	24			0.9	
SPP1 05351	Enclosed Type, ST, ME	35W			5	6
SPP1 12351	Enclosed Type, ST, ME				12	3
SPP1 15351	Enclosed Type, ST, ME		15	2.4		
SPP1 24351	Enclosed Type, ST, ME	60W	24	1.5		
SPP1 05601	Enclosed Type, ST, ME		5	9		
SPP1 12601	Enclosed Type, ST, ME		12	5		
SPP1 15601	Enclosed Type, ST, ME	480W	15	4		
SPP1 24601	Enclosed Type, ST, ME		24	2.5		

### Legend for Description Abbreviations:

- APF: Active Parallel Function (Active Current Sharing)
- ME: Metal Enclosure
- PFC: Power Factor Correction
- PE: Plastic Enclosure
- PF: Parallel Function
- RC: Removable Connector
- ST: Screw Terminal

# Control



**SPD 5W/10W/18W 1-PHASE**



**SPD 30W/60W 1-PHASE**



**SPD 90W/100W 1-PHASE  
SPD REDUNDANT MODULE**



**SPD 120W/240W 1-PHASE**



**SPD 240W 1-PHASE**



**SPD 300W 1-PHASE**



## Front Adjustments and LEDs

The adjustments are placed on the front panel of the SPD power supplies. We have an adjustment trimmer pot which serves to fine tune the output voltage within a span of approximately,  $\pm 10\%$  of the rated voltage.

On the models from 100W up, there is also a sliding switch which has to be used in order to select the single or parallel operation.

Most models have two LEDs, one green and one red, which indicate the operational status.

The green one indicates the output is OK the second one is lit when the output voltage is out of the specified range.

## Spring Loaded Terminals

On all models up to 60W, a choice between spring loaded terminals and screw terminals is provided. Spring loaded terminals allow fast and reliable wiring connection, saving time and money.

All power supplies, from 30W and above, have more than one terminal for the connection of the "+" and the "-" outputs. This feature allows use of smaller conductors for the wiring and simplified parallel connection.

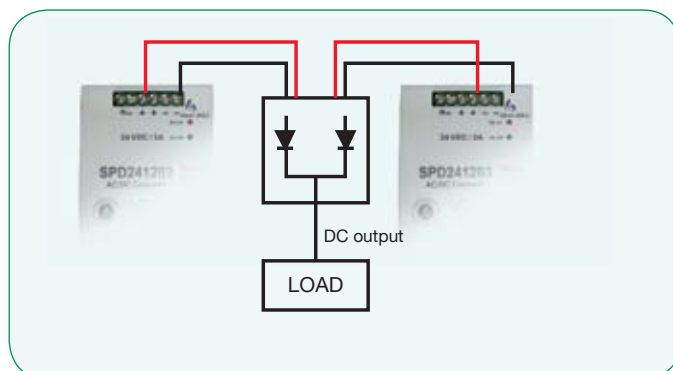
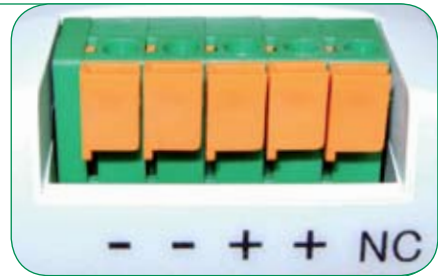

## Redundant Module

The SPD24RM20 redundant module allows for the connection of two or more power supplies, guaranteeing the supply of DC power in case of failure of one of the power supplies.

# DIN-Rail Switching Power Supplies



**SPD 480W 1-PHASE**



**SPD 100W 2-PHASE**



**SPD 120W 3-PHASE**



**SPD 240W 3-PHASE**



**SPD 480W 3-PHASE**



**SPD 960W 3-PHASE**

## Available Terminals

The screw terminals of the single phase power supplies with metal enclosure (120W to 480W) are offered with fixed terminals or removable connectors. The 24VDC output devices have two terminals, identified by Rdy, which provide an external electrical indication of the power status. In case of failure (low output voltage or no output), the internal contact opens, thus indicating to remote devices there is an abnormal situation. The 5, 10 and 18W are not equipped with it.

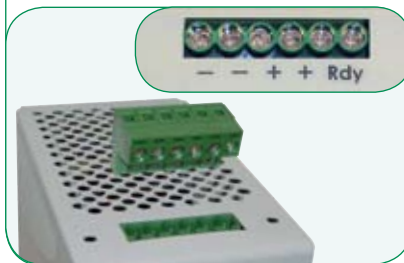

## Main Features

- Single phase AC input 93 to 264VAC and various DC voltages also
- Universal three phase AC input 340 to 575VAC or 480 to 820VDC
- LOW voltage LED indicator
- High efficiency up to 89%
- Fine output voltage regulation
- Short circuit protection
- Overload protection
- Internal input filter
- Operating temperature w/o derating -25°C to +60°C
- Active parallel function (active current sharing)
- UL 1310 Class 2 Output on some types

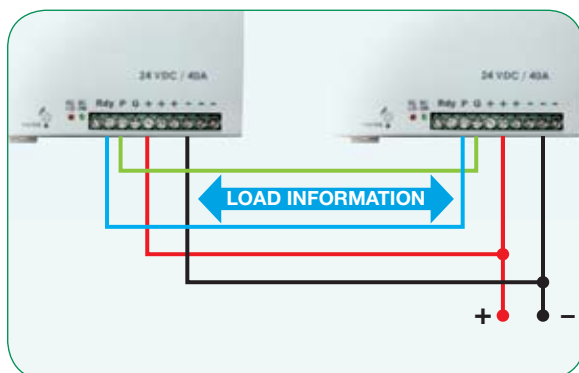

## Active Current Sharing

The 3-phase 960 watt power supplies feature active current sharing. By connecting two wires from one power supply to the other, they exchange information regarding the output current and adapt one another to have equal outputs.

# Low Profile Switching Power Supplies



**SPM1 10W**



**SPM3 30W**



**SPM4 60W**



**SPM5 100W**



### Output Terminals

Double screw terminals for SPM 3, 4 and 5

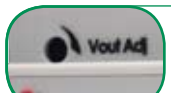

### Vout Adjustment

Allows adjustment of output voltage within a small range to the required value

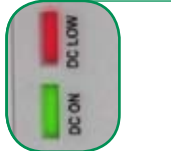

### "LOW" LED

Indicates output voltage too low

### "ON" LED

Indicates power output is OK



### Ventilation Grid

Provides natural cooling of components



### Input Terminals

Quick access for wiring



### DIN Rail Clip

Easy installation on any kind of DIN Rail

## Main Features

- Universal input 90 to 264VAC or 120 to 370VDC
- LOW voltage LED indicator
- High efficiency up to 89%
- Fine output voltage regulation
- Short circuit protection
- Overload protection
- Internal input filter
- Operating temperature w/o derating -25°C to +60°C
- UL 1310 Class 2 output up to 91W
- From 1 to 5 DIN models

## Modular Concept

This family is specifically developed for home and building automation distribution boxes, with just a little more than 55mm/2.18" of depth, which allows flush mounting



on the front panel of the boxes. This concept is modular according to DIN standard.

## Product Line

The availability of models is broad. The 91W version of the SPM5 is Class 2 UL 1310 Listed and has been specifically developed to meet this requirement.

UL 1310 Class 2 compliant models are shown to the right in black.

	5V	12V	15V	24V	24VS
SPM1	7.5W	10W	10W	10W	
SPM3	15W	25W	30W	30W	
SPM4	35W	54W	60W	60W	
SPM5	60W	72W	75W	100W	91W

## Redundant Module

The redundant module allows the connection of two or more power supplies guaranteeing the supply of DC power if one of the power supplies should fail.

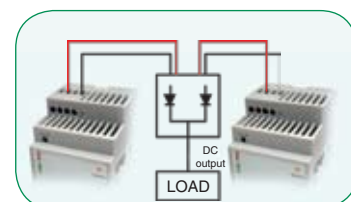

# Enclosed Switching Power Supplies

CARLO GAVAZZI



SPP1 20W



SPP1 35W



SPP1 60W

## Connection

The Enclosed Switching Power Supply meets your needs for AC/DC and DC/DC power requirements.



## Mounting

All the enclosed switching power supplies can be installed either in vertical or horizontal position.



Horizontal Mounting



Vertical Mounting

## Compact Dimensions

The enclosed power supplies feature a very compact design, high efficiency and overall high specifications.

## Main Features

- Universal AC input by 88 to 264VAC or 120 to 375VDC
- Output Voltage: 5V, 12V, 15V, and 24VDC
- Low stand-by power consumption of less than 0.3W
- High efficiency up to 89%
- Short circuit protection
- Internal input filter
- High average efficiency (meets ErP)
- High Operating temperature -40°C to +71°C
- CE, TUV, and cURus approved

## Dimensions



92 x 54 x 30mm  
3.62 x 2.13 x 1.18"



75 x 51 x 28mm  
3.07 x 2 x 1.1"



98 x 82 x 35mm  
3.86 x 3.23 x 1.38"

# The Complete Product Package

## Sense

Inductive and Capacitive Sensors  
Photoelectric Sensors  
Ultrasonic Sensors  
Wind Sensors  
Radar Sensors  
Motion/Presence Vision Sensors  
Conductive Level Sensors  
Limit Switches  
Magnetic Switches  
Safety Interlocks and Light Curtains

## Switch

Solid State Relays  
Contactors and Overloads  
Manual Motor Starters/Protectors  
Soft Starters  
Variable Frequency Drives  
Hybrid Relays  
Electromechanical Relays  
Push Buttons and Pilot Lights

## Control

Energy Management  
Switching Power Supplies  
Digital Panel Meters  
Timers and Counters  
Monitoring Controls  
Current Transformers/Shunts  
PID Controllers  
Surge Arresters  
Safety Control Modules

## Fieldbus

Dupline® Field and Installation Bus  
Building Automation Systems  
Parking Guidance Systems  
Elevator Systems  
DuplineSafe Mining Systems  
Irrigation Systems

## EcoEnergy equipment

Solar Monitoring and Control  
Solar Battery Chargers

## A Global Force in Automation and Energy Solutions

CARLO GAVAZZI has a multitude of sales offices spanning North America (*not to mention our hundreds of distributors*). Therefore, we can be viewed as "your local automation resource" - assisting you every step of the way in finding the proper solution for your various application requirements. Naturally, our job is greatly simplified as we have such a vast range of solutions to offer you via our comprehensive *product package*.

Our worldwide sales offices make us an ideal business partner, *especially for manufacturers of exported machinery*, as our products are available locally and they are RoHS and CE marked.

Argentina • Australia • Austria • Bahrain • Belgium • Bolivia • Bosnia • Brazil • Brunei • Bulgaria • Canada  
Chile • China • Columbia • Croatia • Cyprus • Czech • Denmark • Dominican Republic • Egypt • Estonia  
Finland • France • Germany • Greece • Hungary • Hong Kong • Iceland • India • Indonesia • Iran • Ireland  
Italy • Japan • Jordan • Kenya • Korea • Kuwait • Lebanon • Malaysia • Malta • Morocco • Mauritius • Mexico  
Netherlands • New Zealand • Norway • Pakistan • Papua New Guinea • Paraguay • Peru • Philippines  
Poland • Portugal • Qatar • Romania • Russia • Saudi Arabia • Serbia • Singapore • Slovakia • Slovenia  
South Africa • Spain • Sultanate of Oman • Sweden • Switzerland • Taiwan • Thailand • Tunisia • Turkey  
Ukraine • United Arab Emirates • United Kingdom • Uruguay • United States of America • Venezuela • Vietnam

**USA**  
**CARLO GAVAZZI INC.**  
750 Hastings Lane  
Buffalo Grove, IL 60089  
Tel: 847.465.6100  
Fax: 800.222.2659  
[Sales@CarloGavazzi.com](mailto:Sales@CarloGavazzi.com)

**CANADA**  
**CARLO GAVAZZI (CANADA) INC.**  
2660 Meadowvale Boulevard  
Mississauga, ON L5N 6M6  
Tel: 888.575.2275  
Fax: 905.542.2248  
[Gavazzi@CarloGavazzi.com](mailto:Gavazzi@CarloGavazzi.com)

**MEXICO**  
**CARLO GAVAZZI MEXICO S.A. de C.V.**  
Calle La Montaña no. 18, Fracc. Los Pastores  
Naucalpan de Juárez, EDOMEX CP 53340  
Tel & Fax: 52.55.5373.7042  
[MexicoSales@CarloGavazzi.com](mailto:MexicoSales@CarloGavazzi.com)

• Regional / Area Sales Office  
• District Sales Office

Your Authorized Distributor:

**CARLO GAVAZZI**  
**Automation Components**

**USA** Tel: 847.465.6100 Fax: 800.222.2659

**Canada** Tel: 888.575.2275 Fax: 905.542.2248

**Mexico** Tel and Fax: 52.55.5373.7042

**Website** [www.GavazziOnline.com](http://www.GavazziOnline.com)

**Email** [Info@CarloGavazzi.com](mailto:Info@CarloGavazzi.com)



Visit our website for downloadable data sheets,  
brochures and pricing: [www.GavazziOnline.com](http://www.GavazziOnline.com)